

# *Breadmaker Guide & Cookbook*

**REGAL<sup>®</sup>**

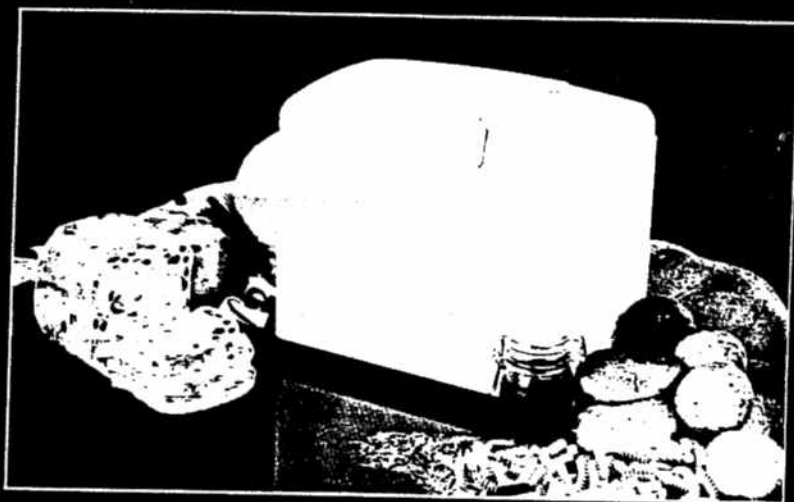

*Model No. K6762*

## **Introduction**

**W**elcome to machine breadmaking! Now you can enjoy the homemade goodness of freshly baked bread without the time consuming mixing and kneading. And, there are no sticky bowls or floured boards to clean. The breadmaker does all the work for you in just one pan.

Before you start, please read the instructions and make certain you have all the proper measuring tools on hand. Although the machine does the work, you still have to do your part by using the correct ingredients and measuring accurately. . . using a soup spoon in place of a measuring spoon practically guarantees a failure. Other factors, such as the temperature of the ingredients and humidity can also affect the finished loaf. Even the brand of flour or yeast may alter the end result. Keep in mind, breadmaking is not a beauty contest. Even the not-so-perfect loaves are often quite tasty. Your next loaf will probably be even better.

During our extensive testing and recipe development we simulated some less-than-ideal conditions and have attempted to tell you how to compensate for them. We've shared that information with you under "Ingredients Substitutions and Tips." We know you'll find this added information useful and we encourage you to read it thoroughly and refer to it often, especially when making a recipe for the first time, or altering a recipe.

If there are three (or fewer) people in your household, you'll probably want to make the smaller size loaf when possible, so it doesn't get stale before you finish it. And, with the Regal Breadmaker it's so easy to make fresh bread almost any time. Warm, homemade bread is a thoughtful gift for a friend who needs a "day brightener," or for a new neighbor. But be prepared - they'll want more!

Homemade bread is great -- and, making it in the Regal Breadmaker is great fun!

### **Power Interruption**

*If the breadmaker is accidentally unplugged, or in the event of a power outage, the breadmaker will automatically resume operation if the power comes on again within 10 minutes of the interruption.*

*When you cannot determine how long the power has been off, discard ingredients and start over.*

# **Table of Contents**

	Page
Introduction . . . . .	2
Power Interruption . . . . .	3
Important Safeguards . . . . .	5
Description of Parts . . . . .	6
Caution for Use and Safety . . . . .	7
Settings . . . . .	8-9
Cycle Times . . . . .	9
Trouble Shooting . . . . .	10
Control Panel . . . . .	11-12
Tips for Breadmaking . . . . .	13
Ingredients Substitutions and Tips . . . . .	14-15
Recipe Conversions . . . . .	15
High Altitude Adjustments . . . . .	16
Adjusting Recipes . . . . .	17-18
Sources For Ingredients . . . . .	18
Operating Instructions, Bread Settings . . . . .	19-22
To Clean Breadmaker . . . . .	23
Bread Recipes . . . . .	24-31
Making Gluten Free Bread . . . . .	32
Recipes for <del>Gluten Free Bread</del> . . . . .	33-36
Tips for Gluten Free Bread . . . . .	37
Making Dough . . . . .	38-43
Using the Automatic Dough Setting . . . . .	38-39
Crust Treatments . . . . .	40-41
Rising, Freezing, Storing . . . . .	42-43
Recipes for Doughs . . . . .	44-49
Making Quick Breads . . . . .	49
Recipes for Quick Breads . . . . .	50
Making Pasta . . . . .	51
Pasta Recipes . . . . .	51
Making Jam . . . . .	52
Jam/Marmalade Recipes . . . . .	52-53
Recipe Index . . . . .	54

# **Before Using Your Breadmaker**

## **IMPORTANT SAFEGUARDS**

When using electrical appliances, basic safety precautions should include the following:

1. READ ALL INSTRUCTIONS.
2. To protect against electrical hazards, do not immerse cord, plug or appliance in water or other liquids.
3. Do not touch hot surfaces. Use handles or knobs. Always use pot holders or oven mitts to handle hot bread pan or hot bread.
4. Close supervision is necessary when any appliance is used by or near children.
5. Unplug from outlet when not in use and before cleaning. Allow to cool before putting on or taking off parts.
6. Avoid contacting moving parts.
7. Do not operate any appliance with a damaged cord or plug, or after the appliance malfunctions or has been damaged in any manner. Return appliance to Regal Ware, Inc., Kewaskum, WI, for examination, repair or adjustment.
8. Do not use attachments not recommended or sold by the appliance manufacturer. This may cause fire, electrical shock or injury.
9. Do not use outdoors.
10. Do not let cord hang over edge of table or counter, or touch hot surfaces.
11. Do not place appliance on or near a hot gas or electric burner or in a heated oven.
12. To disconnect, grip plug and pull from wall outlet. Never pull on the cord.
13. Do not use appliance for other than its intended use.

## **SAVE THESE INSTRUCTIONS**

To reduce the hazard of potential shock, this item has a polarized plug (one blade is wider than the other), which will fit only one way in a polarized outlet. If the plug does not fit the outlet properly, turn the plug the other way; if it still does not fit, contact a qualified electrician for assistance. Never use this plug with an extension cord unless it fits properly. DO NOT ATTEMPT TO DEFEAT THIS SAFETY FEATURE.

## **Household Use Only**

**NOTICE:** a short cord is provided to reduce the risks of becoming tangled in or tripping over a longer cord. Extension cords may be used if care is exercised in their use and the wattage rating is at least as great as the wattage stamped on the base of the appliance. If an extension cord is used, it should be arranged so that it will not drape over the counter or tabletop where it can be reached by children or tripped over accidentally.

## Description of Parts

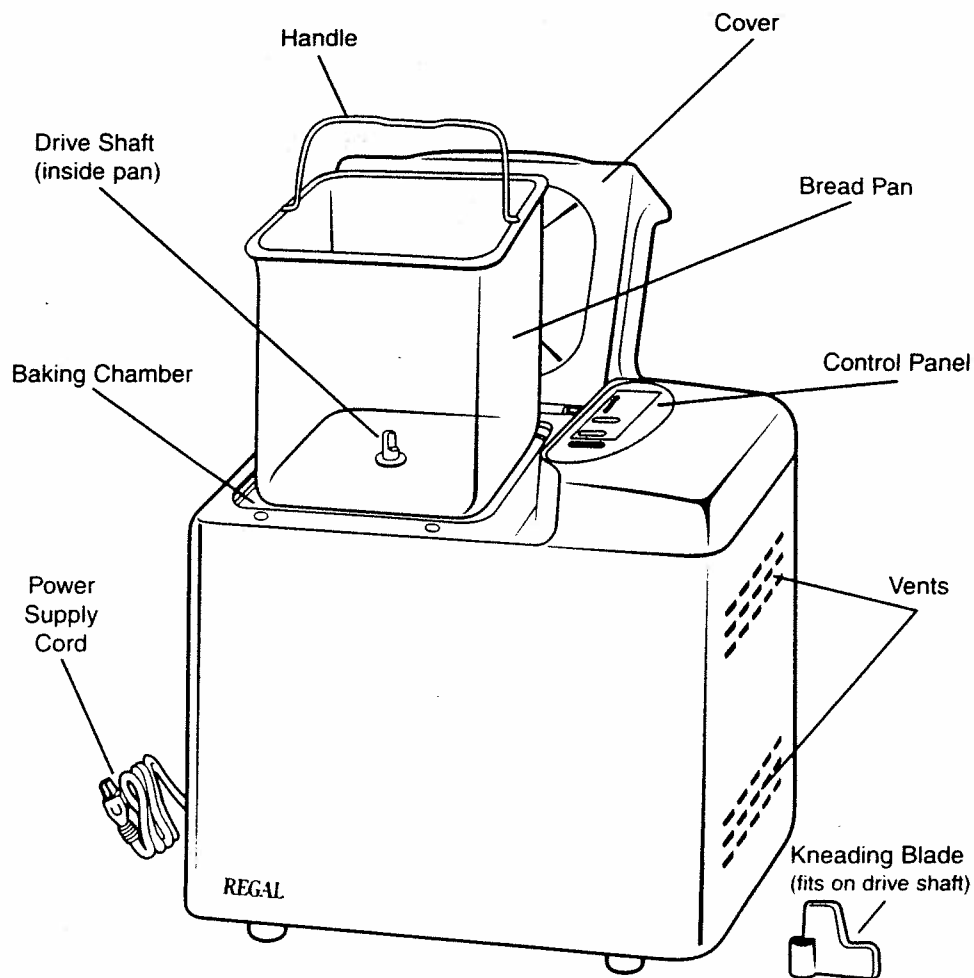

## **Caution for Use and Safety**

Do not use breadmaker on a surface that is not heat resistant, or in an area that is exposed to direct sunlight.

---

Place the breadmaker to allow for 4 inches of clearance on all sides.

---

Plug it into a properly wired wall outlet (120 volts AC only). Keep the breadmaker away from babies and children. They might touch the control buttons and the breadmaker cover gets hot during operation.

---

Do not cover the breadmaker with anything during operation as this may cause a malfunction.

---

Do not open the cover unnecessarily or remove the dough during operation. The cover may be opened to add extra ingredients at the indicated time. Extra water or extra flour may be added during the first kneading cycle if dough appears too dry or too moist. (See page 17-18).

---

Do not touch cover of breadmaker during operation. It will be hot.

---

Do not dent or damage the bread pan. The breadmaker will not operate properly. Call the toll-free number on page 3 for replacement information.

---

Do not immerse the bread pan in water or wash it in a dishwasher. This could cause malfunction of the shaft, or rusting. To clean the outside of the pan, use a damp cloth.

---

Do not immerse the breadmaker, cord or plug in water at any time. This could cause an electrical shock or malfunction.

---

# Settings

Six menu settings allow for making a wide range of breads, doughs, rice, jam, pasta, quick breads and more.

- Basic** This setting is probably used more often than any other because it gives the best results with almost any recipe: standard white bread, raisin bread and more. Total cycle time is 3 hours.
- French** This unique setting produces a heartier crust. It includes a third rise cycle and bakes at a slightly higher temperature which is ideal for French or Italian breads. Total cycle time is 3 hours 50 minutes.
- Rapid** The Rapid setting will make bread faster than other cycles. We suggest that you use the classic white bread recipe and increase the water by 1 to 2 tablespoons. This setting reduces the second knead and final rise times. Total cycle time is 2 hours, 40 minutes. **Note:** this setting does not offer a fruit/nut signal.
- Whole Wheat** Offers longer rise cycles to accommodate the slower rising action for bread containing more than 50% whole wheat flour. Total cycle time is 3 hours 40 minutes.
- Dough/Pasta** This setting is used to prepare dough for rolls, specialty breads, pizza, pasta, etc., which are shaped by hand, allowed to rise a final time and then baked or cooked conventionally. Total cycle time is 1 hour 20 minutes. When cycle is complete, remove the dough and proceed with hand shaping, etc. (See instructions, Pages 38-43 and page 51.)
- Bake Only** This setting is for baking doughs or batter breads (quick breads). Also use this cycle for making jams and rice. Total cycle time is 1 hour.



**Note:** The audible signal for adding raisins or other dried fruits applies to the following settings only: Basic, French, and Whole Wheat.

## Cycle Times

CYCLE SETTINGS AND TIMES						
	Basic	French	Rapid	Whole Wheat	Dough/Pasta	Bake
Primary Knead	10 min.	18 min.	20 min.	10 min.	20 min.	N/A
Primary Rise	20 min.	40 min.	20 min.	25 min.	N/A	N/A
Secondary Knead	15 min.	22 min.	5 min.	20 min.	N/A	N/A
Secondary Rise	25 min.	30 min.	20 min.	45 min.	25 min.	N/A
Punch Down	4 sec.	4 sec.	4 sec.	4 sec.	4 sec.	N/A
Final Rise	45 min.	50 min.	35 min.	70 min.	35 min.	N/A
Bake	1:05	1:10	1:00	50 min.	N/A	1:00
Total Cycle Time	3:00	3:50	2:40	3:40	1:20	1:00
Cool down	1:00	1:00	1:00	1:00	1:00	1:00
Fruit/Nut Signal	Yes	Yes	No	Yes	No	No
Time to Fruit/Nut Signal	40 min.	1:20	N/A	50 min.	N/A	N/A
Time on Display	2:20	2:30	N/A	2:50	N/A	N/A

**Note:** Cycle times on chart are based on the *medium* crust setting. When using the *light* crust setting, the cycle time will be 7 minutes shorter; when using the *dark* setting, time will be 7 minutes longer.

# Trouble Shooting

Always use the breadmaker in a room that is free of drafts and is at least 55°F/13°C, but not warmer than 90°F/32°C. Do not use breadmaker in an unheated garage, outdoors, near a heat vent, or in direct sunlight. Here are some points to consider.

## Before Calling for Service

Problem	Possible Reason	Solution
The unit does not operate after pushing the Start/Stop button.	<ul style="list-style-type: none"><li>● Unplugged</li><li>● Setting was not selected</li><li>● Baking chamber is too warm</li></ul>	<ul style="list-style-type: none"><li>● Plug in</li><li>● Select setting</li><li>● Open cover, remove bread and allow unit to cool with cover open before baking another loaf of bread.</li></ul>
The bread rose too high	<ul style="list-style-type: none"><li>● Too much moisture</li></ul>	<ul style="list-style-type: none"><li>● Decrease liquid by 1-2 tablespoons or add 1-2 tablespoons of flour.</li></ul>
The bread didn't rise high enough.	<ul style="list-style-type: none"><li>● Too much flour</li></ul>	<ul style="list-style-type: none"><li>● Decrease flour by 1-2 tablespoons or increase liquid by 1-2 table- spoons.</li></ul>

# Control Panel

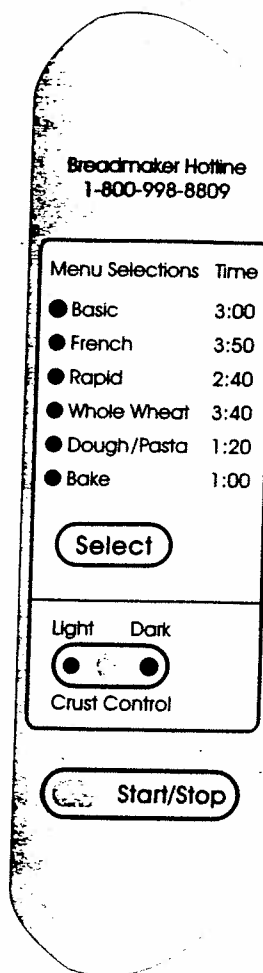

## ● START/STOP Button

Push the Start/Stop button to start the process of the selected setting. The indicator light next to the selected setting will light up. Press the Start/Stop Button to turn off the controlled cool down cycle after baking is completed and you are ready to remove the bread. Or, press Start/Stop if you decide to reset the cycle. To take effect, you must hold down for three seconds. You will hear a beep indicating contact has been made.

● **SELECT Button**

Press the Select button to choose the setting you desire. Each time you press the Select button, the setting will advance in the following sequence:

- **Basic**
- **French**
- **Rapid**
- **Whole Wheat**
- **Dough/Pasta**
- **Bake**

**Note:** a setting must be selected before the Crust Control (crust color) can be selected.

● **CRUST CONTROL**

The Crust Control is automatically preset on the medium crust setting. If you want a lighter or darker crust, press the Crust Control button until the indicator lights up the setting you want. (**Note:** that by choosing the lighter crust setting, the baking time is decreased by 7 minutes; the darker setting increases baking time by 7 minutes).

<b>Setting</b>	<b>Cycle Time (regular crust)</b>	<b>Cycle Time (light crust)</b>	<b>Cycle Time (dark crust)</b>
Basic	3:00	2:53	3:07
French	3:50	3:43	3:57
Rapid	2:40	2:33	2:47
Whole Wheat	3:40	3:33	3:47
Dough/Pasta	1:20	N/A	N/A
Bake	1:00	:53	1:07

# Tips for Breadmakers

## ■ **Measuring With Standard Measures**

**Dry ingredients:** Spoon into standard dry measuring cup until overflowing. Level off with straight-edged spatula.

**Brown sugar or shortening:** press firmly into standard dry measuring cup, or measuring spoon. Level off with straight-edged spatula.

**Baking powder, baking soda, salt, spices, dry milk:** fill standard measuring spoon to overflowing. Level off with straight-edged spatula.

**Liquid ingredients:** place standard liquid measuring cup (8 fluid ounces) on level surface. Fill to specified mark and check measurement at eye level, top of liquid should be even with indicator line on the cup. Use standard measuring spoons for small amounts of liquid (see page 16 for equivalents chart).

## **Hints for Baking Delicious Homemade Breads**

1. Use only fresh ingredients.
2. Yeast is the most important ingredient in bread baking. It

causes the bread to rise. Too little yeast can result in improper rising. Too much yeast can cause over-rising and the dough could stick to the inside of the lid; or it could collapse during baking. In the breadmaker, yeast does not need "proofing" or preliminary fermentation. After each use, always close yeast container tightly and store in a cool, dry place.

3. Measure ingredients exactly.
4. For best results always allow bread to cool before slicing. To slice warm bread, use a sharp serrated-edge knife or electric knife.
5. After cooling bread completely, on a wire rack, store immediately in a tightly sealed plastic bag, plastic wrap or covered container. Do not store in the refrigerator, as this will cause the bread to dry out faster.
6. For longer storage, tightly seal bread in a moisture-proof wrap or bag, and store in freezer.

# Ingredients Substitutions & Tips

## Helpful Hints

- Cheese melts into liquid during baking. Allow for that by reducing liquid when adding cheese to a recipe. Do not *pack* grated cheese into the measuring cup. Lightly spoon into cup.
- Other liquids, such as beer, fruit juices or purees can be used as liquid in the bread.
- Fat, oil or shortening enrich flavor and help keep bread fresh longer. One can be substituted for another in the same amounts.
- Vegetable, canola, corn, peanut, soy or sunflower oil can be used. Unsaturated safflower oil is a good substitute in special health breads. Olive oil produces a softer crust than butter or margarine and is often used in pizza dough to tenderize and flavor the dough. Peanut oil keeps bread fresh longer.
- Milk and water are interchangeable in these recipes. Milk gives bread a velvety texture and adds nutrients. Breads made with water have a heavier, crispier crust and more "open" texture.
- Buttermilk is a good substitution for water or milk. It results in a light, high rising and tender bread. To offset the slight acidity, for every cup of buttermilk, add about  $\frac{1}{4}$  teaspoon baking soda with the dry ingredients. Buttermilk also helps bread stay fresh longer.
- In place of granular (white) sugar, you can use brown sugar, honey, molasses or syrups. **Hint:** Before measuring honey or molasses, oil the measuring spoon or cup with cooking oil. The syrup easily runs off the utensil.
- Add spices and herbs after flour, away from liquid to avoid altering the liquid/flour action.
- To make yeast breads last longer and be slightly higher, use water in which you've cooked potatoes and cooled to room temperature (70-80°F/21-27°C).
- If making bread in a cool room (under 65°F/18°C), use warmer water (100-110°F/38-43°C).
- There are several bread mixes available on the market which can also be used in your breadmaker. Follow the package instructions to make one loaf (1 $\frac{1}{4}$  - 1 $\frac{1}{2}$  pounds).
- If you elect to use "light salt," it must contain both potassium chloride and sodium. Plain potassium chloride will not work.
- Vital gluten is the dried protein taken from the flour by getting rid of the starch. It usually contains 75% protein

and is a good dough enhancer or conditioner for breads that use yeast: especially for whole grain breads, or when using all-purpose flour in place of bread flour. As a guide, add 1 teaspoon vital gluten per cup of all-purpose flour and 1½ teaspoons per cup of whole grain flours in the recipe. Gluten flour is half vital gluten. It is expensive and does not seem to enhance the bread as well as

vital gluten. Vital gluten and gluten flour are usually available in health food stores and through the mail. See page 18 for sources.

- Vinegar or lemon juices are also acceptable dough enhancers. Generally, 1 teaspoon is added to rye bread to enable the rye flour to work with the bread flour for better structure.

## Recipe Conversions

Most of your old family favorites as well as your new bread recipes can be prepared in the Regal Breadmaker. Here are some recipe conversion tips:

1. If your recipe yields two conventional loaves, cut the recipe in half to make one loaf. The breadmaker only makes one loaf at a time.
2. Do not exceed a total of 3 cups of flour. Use the recipes in this book as your guide when converting other recipes.
3. Always measure and add water or other liquids first, followed by the salt. Then add ingredients such as liquid sweetener, shortening, eggs etc. Finally, measure the dry ingredients into the bread pan in the order listed. Carefully place active dry yeast on top of dry ingredients, avoiding contact with the liquid and salt. If bread flour is not available in your area, use an all-purpose flour with a protein content of 14% or higher.
4. To substitute dry milk for fresh, use approximately 2 tablespoons dry milk plus 1 cup water for every cup of milk. **Remember:** fresh milk, cream, eggs, sour cream, etc., should not be used if using the timer on your breadmaker for delayed baking.

# High Altitude Adjustments

At altitudes above 3,000 feet, flour tends to be drier and absorbs less liquid. Slightly more liquid or less flour may be required.

Dough rises faster at higher altitudes. Either sugar or yeast should be reduced slightly to prevent over-rising. See Table for guidelines.

Adjustment	Altitude		
	3,000 ft.	5,000 ft.	7,000 ft.
Reducing yeast. For each teaspoon, decrease by:	1/8 tsp.	1/8 - 1/4 tsp.	1/4 tsp.
Reducing sugar. For each tablespoon, decrease by:	0-1 tsp.	0-2 tsp.	1-3 tsp.
Increasing liquid. For each cup, add:	1-2 tbsp.	2-4 tbsp.	3-4 tbsp.

**NOTE:** Since every recipe is different, some experimentation may be necessary to give you the desired result.

Equivalents				
Cup	= Fluid Ounces	= Tablespoons	= Teaspoons	= Milliliters
1	= 8	= 16	= 48	= 240
7/8	= 7	= 14	= 42	= 210
(3/4 + 2 Tbsp.)				
3/4	= 6	= 12	= 36	= 180
2/3	= 5 1/3	= 10 2/3	= 32	= 158
5/8	= 5	= 10	= 30	= 150
(1/2 + 2 Tbsp.)				
1/2	= 4	= 8	= 24	= 120
1/3	= 2 2/3	= 5 1/3	= 16	= 79
1/4	= 2	= 4	= 12	= 60
1/8	= 1	= 2	= 6	= 30
		1	= 3	= 15
		1/2	= 1 1/2	= 7.5



## Adjusting Recipes

Weather conditions, storage of ingredients, the temperature of ingredients and exactness of measuring ingredients can alter the size, shape or texture of the bread. Once you recognize the cause, adjustments can be made to compensate for variables.

About 5 minutes after you press Start, lift the cover and check the contents of the bread pan. The ingredients will be mixing and starting to form a ball. The dough ball should have an even consistency, if not, an adjustment may be necessary.

When making bread by hand, the old fashioned way, the amount of flour is the control for adjusting. For example, most conventional bread recipes read: 6 to 7 cups flour. That 1 cup difference is the allowance to adjust the dough to the correct consistency. In the Regal Breadmaker, the flour adjustment can be made while the breadmaker is still mixing and kneading. Make the adjustment, 1 tablespoon at a time, during the first knead cycle while the machine is still kneading. If adjusted ingredient didn't completely mix into the dough, press Start/Stop button. To restart, press Select button to reach desired setting, then press Start/Stop button again. If the baked loaf falls while baking, too much liquid was used. Next

time, reduce liquid by one or two tablespoons. If the bread is small, heavy or has a dense, moist texture, the dough was too dry. Next time, increase liquid.

Not all recipes will produce the same size loaf. When using whole grain flours, wheats and grains, the loaf will be shorter.

### Dry Dough

If your breadmaker begins to "knock" while kneading, the dough is too dry. This may occur during cold months, simply add warm water (100-110°F/38-43°C), 1 tablespoon at a time, until the dough looks soft and smooth.

A dough that is dry will remain in a dense ball irregularly shaped instead of a soft ball. When baked, dry doughs will have an uneven or irregular top, possibly cracked, and the finished loaf will be short.

At the end of the kneading, the dough should be soft enough to very slowly relax toward the corners of the bread pan. As the dough rises, it fills into the corners.

When using the Dough cycle, the dough can be a little drier than when you bake bread in the machine. Because it will be removed and shaped by hand, the dough should be manageable, not sticky.

### **Moist Dough**

If the dough contains too much liquid, it will look more like batter rather than dough. If too wet, the dough may rise okay, but then fall during the bake cycle. Or, it could over-rise and "mushroom" over the bread pan, or hit the cover.

If the dough looks too wet and sticky, add flour, 1 tablespoon at a time, until the dough forms a soft pliable ball.

Flour also absorbs moisture from the air, so you may need to adjust the liquid to compensate for humidity and altitude.

### **Sources** (For Gluten, Whole Grains and other Ingredients)

Arrowhead Mills  
Box 2059  
Hereford, TX 79045  
(806) 364-0730

Jaffe Brothers  
P.O. Box 636  
Valley Center, CA 92082  
(619) 749-1133

Kenyon Corn Meal Company  
Usquepaugh, RI 02892  
(401) 783-4054

Walnut Acres  
Denns Creek, PA 17862  
(800) 433-3998

King Arthur Flour  
P.O. Box 876  
Norwich, VT 05055  
(800) 777-4434

TAD Enterprises  
9356 Pleasant  
Tinley Park, IL 60477  
(800) 438-6153

Bob's Red Mill  
5209 S.E. International Way  
Milwaukie, Oregon 97222  
(503) 654-3215

### **Sources** (For Gluten Free & Wheat Free Flours)

Ener-G Foods, Inc.  
P.O. Box 84487  
Seattle, WA 98124  
(800) 331-5222

Gluten Free Pantry  
22 Kreiger Lane  
Glastonbury, CT 06033  
(203) 633-3826

Garden Spot Distributors  
438 White Oak Road  
New Holland, PA 17551  
(800) 829-5100

# Operating Instructions

Before using your breadmaker for the first time, wash inside of bread pan and kneading blade with hot, soapy water; rinse and dry thoroughly. Using a damp dishcloth or sponge, wipe exterior of bread pan, inside of cover and exterior of breadmaker. Do not immerse bread pan or breadmaker in water.

To bake a loaf of bread using one of the standard bread settings (Basic, French, Rapid or Whole Wheat) follow these instructions:

1. Open the cover and remove the bread pan. To remove the bread pan, grasp both sides of the handle and lift up on the handle.

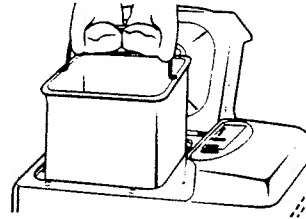

2. Remove any crumbs that may be on the drive shaft. Position the kneading blade on the drive shaft as shown. If the blade is not securely positioned, the ingredients will not be mixed or kneaded properly.

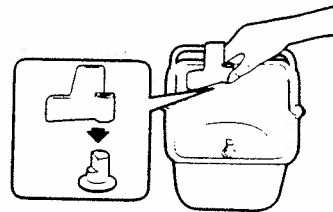

3. All ingredients should be at room temperature (70-80°F/21-27°C). Always measure ingredients into bread pan in the order listed in the recipe.
  - A. Always measure and add the water or other liquids first, except where otherwise directed.
  - B. Then add salt, shortening, flour and other dry ingredients, except yeast.
  - C. Add yeast last to keep it dormant. It is very important to keep the yeast dry and away from the salt. Do not mix. See illustrations on next page.

**Note:** When the room temperature is under 65°F/18°C, use lukewarm water (about 100-110°F/38-43°C) to assist the yeast.

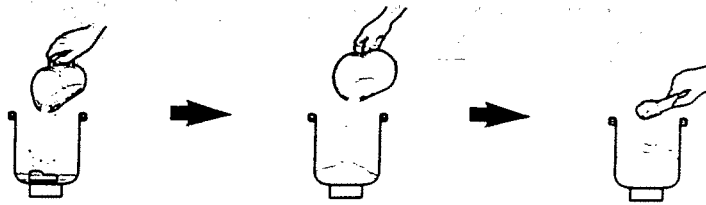

To add yeast, make a small "well" in the mound of flour and pour the dry yeast into it. Do not let the yeast touch the water or salt as the dough may not rise properly. The water will activate the yeast before the ingredients are properly mixed and kneaded.

4. Wipe water or other spills from the outside of the bread pan. Place the bread pan into the baking chamber and press down to lock securely in position. Make sure the bread pan has been set securely in the oven chamber to ensure proper mixing and kneading.

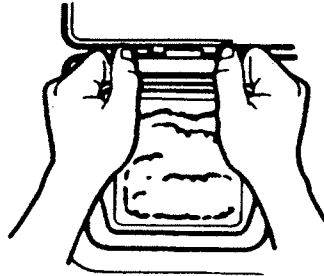

5. Close the cover.
6. Plug into outlet. The unit will signal. No leds should be lit.



7. To choose the proper setting, press the Select button to reach the desired setting. Each time the Select button is pressed the setting will advance and the selected setting light will glow.
8. The breadmaker is automatically preset to bake bread with a medium crust. To choose a darker or lighter crust, press Crust Control until the setting you want lights up.
9. Press Start/Stop Button. The indicator light on the setting you have chosen will remain lit during operation. When baking is finished, the unit will signal. Press Start/Stop.

**Caution:** Steam will escape when the cover is opened. Use a pot holder or oven mitts to open cover to avoid steam burns.

10. After the unit signals, press the Start/Stop button to cancel the cool down cycle and carefully open the cover of the breadmaker. Use potholders or oven mitts to remove the bread pan. Lift the handle and grasp with both hands and pull pan out of breadmaker. Place bread pan on heat-proof surface.

**Note:** If Start/Stop is not pressed after the bake cycle ends, the controlled cool down cycle will operate for one hour after which the breadmaker will shut off. During the Cool-Down cycle, the unit will signal (beep) every eight minutes for the entire 60 minute cycle. When the Cool-Down cycle is completed, the Bake light will shut off.

11. Remove bread from the bread pan as soon as possible after baking. Always press Start/Stop button first, to cancel the Cool-Down cycle and turn the machine off, then remove bread.

The Cool-Down feature will gradually reduce the temperature of the baking chamber for one hour. During the Cool-Down cycle, the unit will signal every eight minutes. However, bread is best when removed right away.

Using potholders or oven mitts, hold the bread pan upside down and gently shake it to remove the bread. The surface of the bread pan is slippery, so be sure you have a firm grip.

If the bread cannot be easily removed, using an oven mitt or potholder, turn the drive shaft on the bottom of the bread pan in both directions to loosen the bread.

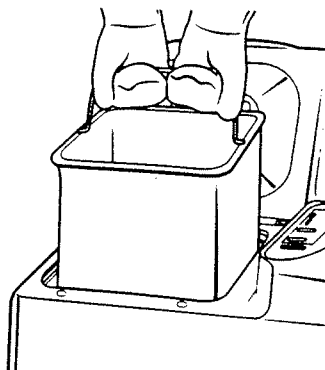

The kneading blade and drive shaft will be very hot. Do not attempt to remove kneading blade with bare hands. If the kneading blade comes out with the bread, use a plastic or wooden utensil to remove it from the bread. Place bread on a wire rack to cool before slicing.

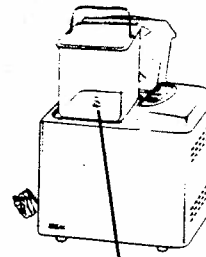

**Drive Shaft**

12. Remove plug from outlet. When removing the plug, always grasp the plug itself and do not pull on the cord.



**CAUTION:** The kneading blade and drive shaft will be hot after baking! Do not attempt to remove kneading blade with bare hands.

# To Clean Breadmaker

Unplug the breadmaker and allow it to cool before cleaning.

NEVER use scouring powder, steel wool pads, or other abrasive materials. And, NEVER use any chemicals such as benzine, paint thinner, alcohol, etc.

## Body

**DO NOT IMMERSE  
BREADMAKER IN WATER**

- Clean your breadmaker, inside and outside, by wiping it with a soft cloth using water and a mild detergent.
- After each use remove crumbs from the baking chamber with a damp cloth.

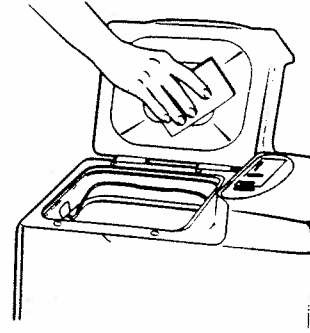

## Bread Pan/Kneading Blade

- Wash inside of bread pan and kneading blade with warm, soapy water; rinse and dry thoroughly. Do not immerse base of bread pan in water as this could cause the drive shaft to malfunction.

**DO NOT USE METAL OBJECTS TO  
CLEAN THE BREAD PAN.**

- As with any of the non-stick cooking utensils in your kitchen, treat the bread pan gently. Do not use metal objects or steel wool, etc., to clean it.
  - If the kneading blade has stuck to the drive shaft, pour warm water in the pan and let stand 15-20 minutes to loosen it.
- DO NOT USE EXCESSIVE FORCE.**
- If the hole of the kneading blade is filled with dough, clean it with a wooden toothpick or small brush.

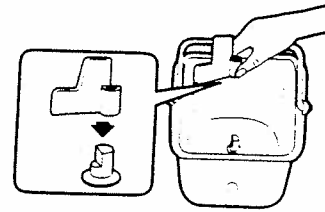

**Note:** The coating inside the bread pan may change color after repeated use. This is caused by heat, moisture and steam, and will not affect the performance of the unit, or the release properties.

## Storage

- Cool breadmaker completely. Wipe off crumbs and moisture before storing.

# Bread Recipes

## Important

Weather conditions such as temperature, altitude or accuracy in measuring can affect the outcome of a loaf. In order to allow you to compensate we have created each recipe with a liquid range ( 6-7 ounces; 8-9 ounces).

We recommend that you start with the smaller amount of liquid. Allow unit to mix for a few minutes before checking the dough consistency. If the dough is dense, irregularly shaped or the unit is making a knocking noise, add 1 tablespoon of water at a time until the dough is soft and pliable.

---

## Classic White (from video)

---

All ingredients at room temperature (70-80°F/21-27°C)

<b>(Regular size)</b>		<b>(Large size)</b>
6-7 ounces	Water	8-9 ounces
1 teaspoon	Salt	1½ teaspoons
1 tablespoon	Butter or Margarine	2 tablespoons
2½ cups	Bread Flour	3 cups
1½ tablespoons	Dry Milk	2 tablespoons
2½ teaspoons	Sugar	1 tablespoon
1¾ teaspoons	Active Dry Yeast	2½ teaspoons

Select Basic or Rapid setting. Press Start/Stop to begin. When the unit signals, the bread is finished; press Start/Stop to cancel the Cool-Down cycle and remove the bread.



---



---

## Old Fashioned

---

### (Large size)

All ingredients at room temperature (70-80°F/21-27°C)

- 6-7 ounces milk
- 1¼ teaspoons salt
- 1 egg
- 1 tablespoon butter or margarine
- 3 cups bread flour
- 1 tablespoon sugar
- 2 teaspoons active dry yeast

Select Basic or Rapid setting. Press Start/Stop to begin. When the unit signals, the bread is finished; press Start/Stop to cancel the Cool-Down cycle and remove the bread.

---



---

## Country White

---

### (Large size)

All ingredients at room temperature (70-80°F/21-27°C)

- 8-9 ounces milk
- 1½ teaspoons salt
- 2 tablespoons butter or margarine
- 3 cups bread flour
- 3 tablespoons sugar
- 2 teaspoons active dry yeast

Select Basic or Rapid setting. Press Start/Stop to begin. When the unit signals, the bread is finished; press Start/Stop to cancel the Cool-Down cycle and remove the bread.

---

## Oatmeal

---

All ingredients at room temperature (70-80°F/21-27°C)

**(Regular size)**

6-7 ounces  
1 teaspoon  
1½ tablespoons  
1 tablespoon  
⅓ cup  
2 cups  
2 teaspoons

Water  
Salt  
Honey  
Butter or Margarine  
Quick Cook Oats  
Bread Flour  
Active Dry Yeast

**(Large size)**

8-9 ounces  
1¼ teaspoons  
2 tablespoons  
1½ tablespoons  
⅓ cup  
2½ cups  
2¼ teaspoons

<sup>10/3</sup> 8 oz  
EXCELLENT

Select Basic setting. Press Start/Stop to begin. When the unit signals, the bread is finished; press Start/Stop to cancel the Cool-Down cycle and remove the bread.

---

## Oat Bran

---

All ingredients at room temperature (70-80°F/21-27°C)

**(Regular size)**

6-7 ounces  
1 teaspoon  
1 tablespoons  
1½ tablespoons  
¼ cup  
2 cups  
1½ tablespoons  
1½ teaspoons

Water  
Salt  
Butter or Margarine  
Honey  
Oat Bran  
Bread Flour  
Dry Milk  
Active Dry Yeast

**(Large size)**

8-9 ounces  
1¼ teaspoons  
1½ tablespoons  
2 tablespoons  
½ cup  
2½ cups  
2 tablespoons  
2¼ teaspoons

Select Basic setting. Press Start/Stop to begin. When the unit signals, the bread is finished; press Start/Stop to cancel the Cool-Down cycle and remove the bread.

---

## Raisin

---

All ingredients at room temperature (70-80°F/21-27°C)

**(Regular size)**

6-7 ounces  
1 teaspoon  
1 tablespoon  
2¼ cups  
1½ tablespoons  
1 tablespoon  
¾ teaspoon  
1½ teaspoons  
¾ cup  
½ cup

Water  
Salt  
Butter or Margarine  
Bread Flour  
Sugar  
Dry Milk  
Cinnamon  
Active Dry Yeast  
Raisins  
Chopped Walnuts

**(Large size)**

8-9 ounces  
1½ teaspoons  
1½ tablespoons  
3 cups  
3 tablespoons  
1½ tablespoons  
1 teaspoon  
2 teaspoons  
1 cup  
½ cup

Select Basic setting. Press Start/Stop to begin. When the unit signals (40 minutes into the cycle), slowly add raisins and nuts a few at a time. When the unit signals again, the bread is finished; press Start/Stop to cancel the Cool-Down cycle and remove the bread.

---

## Cottage Cheese Chive

---

**(Large size)**

All ingredients at room temperature (70-80°F/21-27°C)

¾ cup cottage cheese  
1 egg  
1 teaspoon salt  
1 tablespoon butter or margarine  
½ cup water  
2½ cups bread flour  
2 tablespoons dried chives  
1 tablespoon sugar  
1½ teaspoons active dry yeast

Select Basic setting. Press Start/Stop to begin. When the unit signals, the bread is finished; press Start/Stop to cancel the Cool-Down cycle and remove the bread.

---



---

## Rye

---

### (Large size)

All ingredients at room temperature (70-80°F/21-27°C)

- 8-9 ounces water
- 1 teaspoon salt
- 1 tablespoon vegetable oil
- 1½ tablespoons honey
- ½ teaspoon white vinegar
- 2 cups bread flour
- 1 cup rye flour
- 1½ tablespoons powdered buttermilk
- 1 tablespoon caraway seeds
- 1½ teaspoons vital wheat gluten
- 1¼ teaspoons active dry yeast

Select Basic or French setting. Press Start/Stop to begin. When the unit signals, the bread is finished; press Start/Stop to cancel the Cool-Down cycle and remove the bread.

---



---

## French

---

### (Large size)

All ingredients at room temperature (70-80°F/21-27°C)

- 8-9 ounces water
- 1½ teaspoons salt
- 2 tablespoons vegetable oil
- 3 cups bread flour
- 2 teaspoons sugar
- 2 teaspoons active dry yeast

Select French setting. Press Start/Stop to begin. When the unit signals, the bread is finished; press Start/Stop to cancel the Cool-Down cycle and remove the bread.

---

## Honey French

---

**(Large size)**

All ingredients at room temperature (70-80°F/21-27°C)

- 8-9 ounces water
- 1 teaspoon salt
- 2 teaspoons olive oil
- 1 tablespoon honey
- 3 cups bread flour
- 2 teaspoons active dry yeast

Select French setting. Press Start/Stop to begin. When the unit signals, the bread is finished; press Start/Stop to cancel the Cool-Down cycle and remove the bread.

---

## Italian

---

**(Large size)**

All ingredients at room temperature (70-80°F/21-27°C)

- 8-9 ounces water
- 1¼ teaspoons salt
- 1½ teaspoons vegetable oil
- 3 cups bread flour
- 1 teaspoon sugar
- 2 teaspoons active dry yeast

Select French setting. Press Start/Stop to begin. When the unit signals, the bread is finished; press Start/Stop to cancel the Cool-Down cycle and remove the bread.

---

## Cracked Wheat

---

### (Large size)

All ingredients at room temperature (70-80°F/21-27°C)

8-9 ounces water  
1 teaspoon salt  
2 tablespoons butter or margarine  
1½ tablespoons honey  
2 cups bread flour  
1 cup whole wheat flour  
⅓ cup cracked wheat  
2 teaspoons active dry yeast

Select Basic or Whole Wheat setting. Press Start/Stop to begin. When the unit signals, the bread is finished; press Start/Stop to cancel the Cool-Down cycle and remove the bread.

---

## Honey Wheat

---

### (Large size)

All ingredients at room temperature (70-80°F/21-27°C)

¾ cup wheat flakes  
1½ tablespoons wheat bran  
7-8 ounces water  
1 teaspoon salt  
2 tablespoons honey  
1 tablespoon butter or margarine  
2½ cups bread flour  
2 teaspoons active dry yeast

Select Basic or Whole Wheat setting. Press Start/Stop to begin. When the unit signals, the bread is finished; press Start/Stop to cancel the Cool-Down cycle and remove the bread.

---

## Whole Wheat II

---

**(Large size)**

All ingredients at room temperature (70-80°F/21-27°C)

- 8-9 ounces water
- 1½ teaspoons salt
- 1½ tablespoons butter or margarine
- 2½ cups bread flour
- ¾ cup whole wheat flour
- 2 tablespoons sugar
- 1½ tablespoons dry milk
- 2 teaspoons active dry yeast

Select Basic or Whole Wheat setting. Press Start/Stop to begin. When the unit signals, the bread is finished; press Start/Stop to cancel the Cool-Down cycle and remove the bread.

---

## Whole Wheat - 100%

---

**(Large size)**

All ingredients at room temperature (70-80°F/21-27°C)

- 8-9 ounces water
- 1½ teaspoons salt
- 1 tablespoon vegetable oil
- 2 tablespoons honey
- 1 tablespoon molasses
- 3 cups whole wheat flour
- 1 tablespoon vital wheat gluten
- 1¼ teaspoons active dry yeast

Select Basic or Whole Wheat setting. Press Start/Stop to begin. When the unit signals, the bread is finished; press Start/Stop to cancel the Cool-Down cycle and remove the bread.

# Gluten Free Bread

These Gluten Free recipes and guidelines were developed by Red Star® Yeast & Products especially for Regal Ware, Inc.

## Instructions for Making Gluten Free Breads

1. In a medium sized bowl, combine all wet ingredients; whisk together and carefully pour into bread pan.
2. Measure dry ingredients into large bowl; mix well. Add to wet ingredients in bread pan.
3. Carefully seat pan in bread-maker.
4. Select Dough cycle; press Start/Stop.
5. After mixing action begins, using a rubber spatula, help any unmixed ingredients into the dough. Do not interfere with the mixing and kneading blade; keep spatula to edges of pan and on top of batter.
6. When Dough cycle is complete, press and hold in Start/Stop. Select Bake cycle; press Start/Stop.
7. Remove pan from bread-maker when Bake cycle is complete. Cool bread in pan 10 to 15 minutes.
8. Invert pan and shake gently to remove bread. Cool upright on a rack before slicing.

## Substitutions when Making Gluten Free Breads

- Fructose, molasses and honey can be used in place of sugar.
- Any vegetable oil or butter in place of canola oil.
- Rice flour in place of potato starch.
- Tofu in place of ricotta cheese.
- Lactose-free milk in place of dry milk or water; use equal proportions.
- Pulverized Nut-quick and dry baby formulas such as Isomil, Prosobee and Pregestimil, may be used in place of dry milk for soy and lactose intolerance. Use  $\frac{1}{3}$  cup to replace  $\frac{1}{2}$  cup dry milk.
- Egg replacer in place of eggs. To substitute 3 eggs, use 8 teaspoons egg replacer. Mix with dry ingredients; add  $\frac{3}{4}$  cup water with wet ingredients.

**Note:** Red Star® Active Dry Yeast does not contain wheat gluten or other cereal proteins that cause an allergic reaction in people with gluten intolerance.



---

## Gluten Free White Bread

---

All ingredients at room temperature (70-80°F/21-27°C)

### Wet Ingredients

- 3 eggs
- 1½ cups water
- 3 tablespoons canola oil
- 1 teaspoon cider vinegar

### Dry Ingredients

- 1 pkg (2¼ teaspoons) RED STAR® Active Dry Yeast
- ¾ cups white rice flour
- 2½ teaspoons xanthan gum
- 1½ teaspoons salt
- ½ cup dry milk powder
- 3 tablespoons sugar

See instructions on page 32 for making gluten free bread.

---

## Gluten Free Cheddar Cheese Bread

---

All ingredients at room temperature (70-80°F/21-27°C)

### Wet Ingredients

- 3 eggs
- 1¾ cups water
- 2 tablespoons canola oil

### Dry Ingredients

- 1 pkg (2¼ teaspoons) RED STAR® Active Dry Yeast
- 2 cups white rice flour
- 1 cup brown rice flour
- ¼ cup dry milk powder
- 2 tablespoons sugar
- 1 tablespoon instant minced onions (optional)
- 1 tablespoon poppy seeds (optional)
- 3½ teaspoons xanthan gum
- 1½ teaspoons celery seeds (optional)
- 1½ teaspoons dried dill weed (optional)
- 1 teaspoon salt
- 1½ cups (6 ounces) grated sharp Cheddar cheese

See instructions on page 32 for making gluten free bread.

---

## Gluten Free Cinnamon Raisin Bread

---

All ingredients at room temperature (70-80°F/21-27°C)

### Wet Ingredients

- 3 eggs
- 1½ cups water
- 3 tablespoons canola oil
- 1 teaspoon cider vinegar

### Dry Ingredients

- 1 pkg (2¼ teaspoons) RED STAR® Active Dry Yeast
- 2 cups white rice flour
- ⅔ cup potato starch
- ⅓ cup tapioca flour
- 2½ teaspoons xanthan gum
- 1½ teaspoons salt
- 3 tablespoons sugar
- 2 teaspoons ground cinnamon
- ½ cup raisins

See instructions on page 32 for making gluten free bread.

---

## Gluten Free Mock Limpa Bread

---

All ingredients at room temperature (70-80°F/21-27°C)

### Wet Ingredients

- 3 eggs
- 3 tablespoons molasses
- 1 teaspoon cider vinegar
- 1½ cups water
- 3 tablespoons canola oil

### Dry Ingredients

- 1 package (2¼ teaspoons) RED STAR® Active Dry Yeast
- 2 cups brown rice flour
- ½ cup tapioca flour
- ½ cup potato starch
- 1 tablespoon xanthan gum
- 1 tablespoon fennel seeds
- 1½ teaspoons salt
- ½ cup dry milk powder
- 3 tablespoons sugar
- 2 teaspoons grated orange zest

See instructions on page 32 for making gluten free bread.

---

## Gluten Free Sourdough Starter

---

Rice flour has the ability to ferment easily, creating a wonderful base for delicious breads with a slightly sour flavor. Once made, sourdough starter can be used over and over again. Replenish it each time it is used to nourish the yeast and keep the starter alive. As the starter gets older, the flavor will become tangier. Therefore, baked products made with aged starters will have more sourdough flavor. The starter serves as the leavening, so no additional yeast is needed.

**To make a starter:** In a 4 cup glass, plastic or stainless steel container, combine 1 cup water (110°-115°F/43°-46°C) with 1 package (2¼ teaspoons) RED STAR® Active Dry Yeast and 1½ cups white rice flour. The mixture will be thick. Cover loosely with plastic wrap or foil. Let stand in a warm place 1 to 3 days, stirring 2 or 3 times each day. The starter will rise and fall during the fermentation period; it becomes thinner as it stands. When the starter is developed, it is bubbly and may have a liquid layer on top; stir into the starter before using. The starter can then be used for baking or placed in the refrigerator to use later.

**To replenish starter:** Always have at least 1 cup of starter left over. Add 1 cup of water (110°-115°F/43°-46°C) and 1½ cups white rice flour; mix well. Cover loosely and let stand in a warm place for 12 hours. The starter can then be used for baking or placed in the refrigerator to use later.

---

## Gluten Free Sourdough White Bread

---

All ingredients at room temperature (70-80°F/21-27°C)

### Wet Ingredients

3 eggs  
¾ cups sourdough starter  
1 cup water  
¾ cup ricotta cheese\*  
¼ cup honey  
2 tablespoons canola oil  
1 teaspoon cider vinegar

### Dry Ingredients

2 cups white rice flour  
¾ cup potato starch  
½ cup tapioca flour  
½ cup dry milk powder  
3½ teaspoons xanthan gum  
1½ teaspoons salt

See instructions on page 32 for making gluten free bread.

---

## Gluten Free Sourdough Rye Bread

---

All ingredients at room temperature (70-80°F/21-27°C)

### Wet Ingredients

3 eggs  
¼ cup molasses  
¾ cup sourdough starter  
1 cup water  
¾ cup ricotta cheese\*  
2 tablespoons canola oil  
1 teaspoon cider vinegar

### Dry Ingredients

2 cups white rice flour  
¾ cup potato starch  
¼ cup tapioca flour  
½ cup dry milk powder  
3½ teaspoons xanthan gum  
1½ teaspoons salt  
1 tablespoon caraway seeds  
2 teaspoons instant coffee

\*Whole, part skim or nonfat ricotta cheese.

See instructions on page 32 for making gluten free bread.

## Tips for Successful Gluten Free Breads

1. Yeast may be used cold. All other ingredients should be at room temperature (70°-80°F/21°-27°C).
2. Combine the liquid ingredients in a mixing bowl and whisk together before adding to bread-pan.
3. All dry ingredients, including the RED STAR® Active Dry Yeast, should be thoroughly blended together before adding on top of the wet ingredients.
4. The consistency of the dough for gluten-free breads is similar to that of quick breads—stiffer than a cake batter, but not as stiff as a cookie dough.
5. Humidity, the type of flour and the brand all influence the amount of liquid necessary for the proper consistency.
6. Xanthan gum and guar gum may be interchanged, although some people have a laxative effect from guar gum. Methylcellulose is not a practical substitute.
7. To correct grainy or crumbly bread, increase egg replacer or xanthan gum. Unflavored gelatin is another choice, however, a moister bread will result.
8. One teaspoon cider vinegar added to the wet ingredients of any bread recipe acts as a preservative.
9. Eggs used in these recipes should measure ¼ cup each.
10. Potato starch is excellent for baking when combined with other flours. Often potato starch is labeled potato starch flour. Potato flour is much heavier and cannot be substituted for potato starch.
11. If, at the completion of the Dough cycle, additional rising is needed, allow the dough to remain in the pan for 15 to 30 minutes with the machine off. Then select Bake.
12. If you have questions or problems relating to these bread recipes, call Red Star® Yeast and Product 1-800-4-CELIAC (1-800-423-5422).

## Using The Automatic Dough Setting

1. Open the cover and remove the bread pan. To remove bread pan, lift handle, grasp both sides of it and pull up.

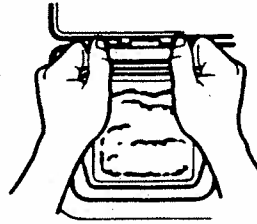

2. Remove any crumbs that may be on the drive shaft. Position the kneading blade on the drive shaft as shown. **Important:** if the blade is not positioned securely, the ingredients will not be mixed or kneaded properly.

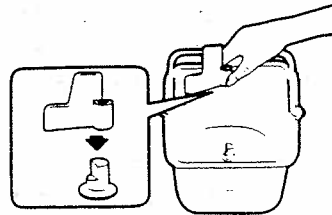

3. Measure room-temperature ingredients into bread pan. Add the ingredients in the order listed in the recipe, with the yeast last, as shown below.

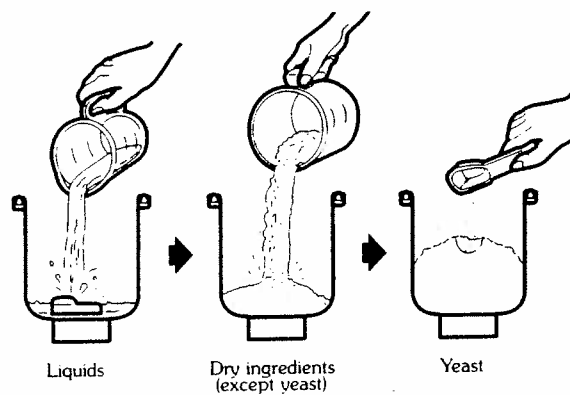

4. Wipe water or other remains from the outside of the bread pan. Place the bread pan into the baking chamber and press down to lock securely in position. Make sure the bread pan has been set securely in the baking chamber to ensure proper mixing and kneading.

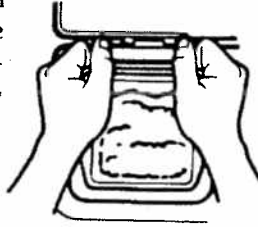

5. Close the cover.



6. Plug into outlet. Insure no led's are lit.

7. Press Select button until Dough/Pasta setting appears on the display. Each time the button is pressed you will hear a beep and the cycle will advance.
8. Press Start/Stop button.

When dough is ready (1 hour, 20 minutes), the unit will signal.

9. When using the Dough/Pasta setting, the bread pan is not hot. Press Start/Stop and open the cover.

To remove the bread pan, lift handle and grasp with both hands. Pull pan out of breadmaker.

### **Prepare Dough for Baking**

1. Lightly sprinkle all-purpose flour onto a pastry mat or board. Using a rubber spatula or wooden spoon, remove dough from bread pan and place on lightly floured surface. Knead by hand 2 or 3 times to release the air. If dough is easy to handle without flour, shape on a lightly oiled, clean countertop.
2. Shape dough into your favorite rolls, coffee cake, etc. Cover dough with a clean kitchen towel and let rise until almost doubled in size, about 1 hour.
3. Bake in preheated (350°F/177°C) oven 30-35 minutes, until golden brown. Remove from pans, then cool on a wire rack or serve warm.

### **Crust Treatments (use only with Dough Setting)**

After the rolls rise, just before baking, gently apply desired glaze with a pastry brush if desired. Bake as directed in recipe.

- For a shiny golden crust, use Egg Glaze or Egg Yolk Glaze.
- For a shiny chewy crust, use Egg White Glaze (crust will be lighter colored).

#### **Egg Glaze**

Mix 1 slightly  
beaten egg  
with 1 tablespoon  
water or milk.

#### **Egg Yolk Glaze**

Mix 1 slightly  
beaten egg yolk  
with 1 tablespoon  
water or milk.

#### **Egg White Glaze**

Mix 1 slightly  
beaten egg white  
with 1 tablespoon  
water.

**Note:** To keep unused egg yolk fresh for several days, cover with cold water and store in refrigerator in a covered container.



**Powdered Sugar Glaze**  
**(for Coffee Cakes and Sweet Rolls)**

1 cup sifted powdered sugar  
1 teaspoon butter or margarine, softened  
1 or 2 tablespoons water or milk  
½ teaspoon vanilla

In small bowl, blend ingredients until smooth. Spread or drizzle on slightly warm coffee cake, cinnamon rolls, etc.

**Hint:** To reheat yeast rolls, place in a clean brown paper bag, fold to close opening. Sprinkle outside of bag with water. Place the bag of rolls in a 325°F/163°C oven for about 10 minutes, or until heated through. Or, place rolls on a large sheet of foil. Sprinkle with a few drops of water. Wrap securely and heat in 325°F/163°C oven, 10-12 minutes.

## Rising

### To reduce rising time of dough prepared in your bread-maker

- Preheat conventional oven to 200°F/93°C for 5 minutes, then turn off oven. Shape dough, place on baking utensil as directed and cover with a clean kitchen towel. Place dough in oven until doubled in size. This will reduce rising time by about one-half.
- If television is in use, stand pan of dough on top of TV to rise. It is a good source of heat and, if you are watching a program, you will not forget about the dough.
- Recipes using whole grain or unrefined flours may not rise as much as those using white bread flour (these contain less gluten). These heavier breads may fall slightly in the center. This is normal and will not affect the flavor. Vital wheat gluten can be added to improve the shape and volume of bread made with low gluten flours (see pages 14 & 15).

## Freezing

For best results, store unbaked yeast dough in your freezer for no more than two weeks.

### To freeze unbaked bread dough

- Shape loaves and wrap in plastic wrap or foil. When you shape the loaf, be sure it fits easily into the baking pan as it will spread a little before freezing. Place wrapped loaf on a flat surface in your freezer so it will keep its shape until frozen.
- To bake: remove dough from freezer, unwrap, and place in greased loaf pan (size specified in recipe). Cover, let thaw, and rise in a warm place until almost doubled in size, about 6 hours for a standard size loaf. Or, thaw dough in refrigerator overnight, then unwrap, place dough in pan, and let rise in a warm place for approximately 2 hours.

### **To freeze unbaked rolls**

- Shape rolls and place on greased baking sheets, or in muffin pans as indicated in recipe. Cover rolls with plastic wrap or foil and place in freezer. Rolls shaped in muffin pans are best frozen and stored in the pans. Rolls shaped on baking sheets should be removed as soon as they are completely frozen and placed in freezer bags or wrapped securely. Label each package with date and quantity.
- To bake: remove rolls from freezer about 2 hours before baking. If not already in a pan, place 1 inch apart on greased baking pan. Cover pan loosely with a clean cloth and set in a warm place to thaw and rise until almost doubled in size (approximately 1½ to 2 hours). Bake as directed in recipe.
- You can also wrap and freeze unshaped dough right after the first rise and after you have punched it down. To use, thaw dough about 3 hours at room temperature, or overnight in the refrigerator; then shape, cover, let rise, and bake as directed in recipe.

## **Storing**

### **Keeping your bread fresh**

- There are no preservatives in your homemade bread, so store cooled loaf in a tightly sealed plastic bag. If desired, enclose a stalk of celery in the bag to keep bread fresh longer. Do not store in the refrigerator as this causes bread to dry out faster.
- Water in which potatoes have been cooked is an excellent variation for other liquid in the recipe. This will aid in keeping the bread fresh longer.

---

## Bread Pretzels

---

All ingredients at room temperature (70-80°F/21-27°C)

6 ounces water  
¼ teaspoon salt  
2 cups bread flour  
½ teaspoon sugar  
1½ teaspoons active dry yeast  
1 egg (slightly beaten)  
1-2 tablespoons coarse salt

Measure all ingredients, except egg and coarse salt, into bread pan. Select Dough/Pasta setting. Press Start/Stop to begin. When the unit signals, the dough is finished; press Start/Stop and remove dough.

Preheat oven to 450°F/232°C. Divide dough into 12 pieces. Roll each into 8 inch rope. Form into pretzel shape or leave in a stick shape. Place on a greased cookie sheet, brush each with beaten egg. Sprinkle with coarse salt. Bake in preheated oven for 12-15 minutes.

---

## Bran Buns

---

All ingredients at room temperature (70-80°F/21-27°C)

6 ounces water  
¾ teaspoon salt  
⅓ cup butter or margarine  
1 egg  
2½ cups bread flour  
⅓ cup wheat bran  
3 tablespoons sugar  
2¼ teaspoons active dry yeast

Measure all ingredients into the bread pan. Select Dough/Pasta setting. Press Start/Stop to begin. When the unit signals, the dough is finished; press Start/Stop and remove dough. Divide dough and shape as desired.

Makes 12 buns or 24 rolls.

---

## Addie's Coffee Cake

---

All ingredients at room temperature (70-80°F/21-27°C)

- 5-6 ounces milk
- 1 teaspoon salt
- 1 egg yolk
- 1 tablespoon butter or margarine
- 2¼ cups bread flour
- ¼ cup sugar
- 2 teaspoons active dry yeast

Measure all ingredients into the bread pan. Select Dough/Pasta setting. Press Start/Stop to begin. When the unit signals, the dough is finished; press Start/Stop and remove dough. Pat dough into greased 9 inch round, or 5 x 7 inch oblong cake pan. Add top-  
ping.

### Topping

- 2 tablespoons butter, melted
- ½ cup sugar
- 1 teaspoon ground cinnamon
- ½ cup chopped pecans
- powdered sugar glaze (page 41), optional.

Drizzle butter over dough. In small bowl, mix sugar, cinnamon and nuts; sprinkle onto butter. Cover; let rise in warm place about 30 minutes. Bake in preheated oven (350°F/177°C) 20-25 minutes, until golden brown. Cool 10 minutes in pan on rack. Drizzle with powdered sugar glaze if desired (see page 41.)  
Makes 12 servings.

---

## Reuben Bake

---

All ingredients at room temperature (70-80°F/21-27°C)

- 7-8 ounces water
- $\frac{3}{4}$  teaspoon salt
- 2 tablespoons oil
- 1 tablespoon molasses
- 1 cup rye flour
- 1 cup bread flour
- 2 teaspoons caraway seeds
- 2 teaspoons dried minced onion
- 2 teaspoons active dry yeast

Measure all ingredients into the bread pan. Select Dough/Pasta setting. Press Start/Stop to begin. When the unit signals, the dough is finished; press Start/Stop and remove dough. Pat dough into greased 9 inch round cake pan. Add topping listed below.

### Topping

- $\frac{1}{4}$  cup mayonnaise
- $1\frac{1}{2}$  tablespoons prepared mustard
- 2 teaspoons prepared horseradish
- $2\frac{1}{2}$  to 3 ounces corned beef, chopped
- 1 can (8 ounces) sauerkraut, well drained
- 1 cup (4 ounces) shredded Swiss cheese

In small bowl, combine mayonnaise, mustard, horseradish; spread over dough. Cover with waxed paper and let stand 30 minutes. Preheat oven to 350°F/177°C. Layer corned beef and sauerkraut on dough. Top with cheese. Bake 30-35 minutes. Cut into wedges to serve.

Makes 4-6 servings.

---

## Whole Wheat Pizza Crust

---

All ingredients at room temperature (70-80°F/21-27°C)

- 7-8 ounces water
- ¾ teaspoon salt
- 1 tablespoon olive or vegetable oil
- 1 tablespoon honey
- 2¼ cups whole wheat flour
- ¼ cup wheat germ
- 2¼ teaspoons active dry yeast

Measure all ingredients into the bread pan. Select Dough/Pasta setting. Press Start/Stop to begin. When the unit signals, the dough is finished; press Start/Stop and remove dough.

Pat dough into 12 x 15 inch jelly roll pan or greased 12 inch round pizza pan. Let stand for 10 minutes. Preheat oven to 400°F/204°C. Spread pizza sauce over dough, add desired toppings (see page 48) and bake 15-20 minutes, or until crust is golden brown.

---

## Pizza Crust

---

All ingredients at room temperature (70-80°F/21-27°C)

- 7-8 ounces water
- ¾ teaspoon salt
- 2 tablespoons olive oil
- 2½ cups all-purpose flour
- 2 teaspoons sugar
- 2 teaspoons active dry yeast

Measure all ingredients into the bread pan. Select Dough/Pasta setting. Press Start/Stop to begin. When the unit signals, the dough is finished; press Start/Stop and remove dough.

Pat dough into 12 x 15 inch jelly roll pan or greased 12 inch round pizza pan. Let stand for 10 minutes. Preheat oven to 400°F/204°C. Spread pizza sauce over dough, add desired toppings (see page 48) and bake 15-20 minutes, or until crust is golden brown.

## Pizza Toppings

- 1 cup prepared pizza sauce
- 1 pkg. (3½ ounces) sliced pepperoni
- ½ pound bulk pork sausage, browned and drained
- 1 can (4 ounces) mushroom stems & pieces, drained
- ⅓ cup chopped onions
- 1 cup chopped green peppers
- 1 cup shredded mozzarella cheese

---

## Cinnamon Rolls

---

All ingredients at room temperature (70-80°F/21-27°C)

- 1 recipe Old Fashioned Bread (page 25)
- 2 tablespoons butter or margarine
- ¼ cup sugar
- 2 teaspoons ground cinnamon
- 1 recipe Powdered Sugar Glaze (page 41)

Measure all ingredients into the bread pan except the Powdered Sugar Glaze. Select Dough/Pasta setting. Press Start/Stop to begin. When the unit signals, the dough is finished; press Start/Stop and remove dough. On a lightly floured surface, roll dough into rectangle (15 x 9 inches); spread soft butter on dough. Mix sugar and cinnamon; sprinkle over butter. Roll up tightly, beginning at 15 inch side. Pinch edges to seal. Stretch roll to make even. Cut nine 1½ inch slices. Arrange in greased 9 x 9 x 2 inch square pan, spacing evenly. Cover; let rise until double in size; about 40 minutes. Preheat oven to 375°F/191°C. Bake 25-30 minutes, or until golden brown. Cool on wire rack for 10 minutes. Top warm rolls with glaze.

Makes 9 rolls.



---

## Focaccia

---

All ingredients at room temperature (70-80°F/21-27°C)

8-9 ounces water  
3 tablespoons olive oil (for dough)  
1 teaspoon salt  
1-2 cloves garlic, crushed  
1½ teaspoons dried rosemary  
3 cups bread flour  
1½ tablespoons olive oil (for topping)  
½ cup sun dried tomatoes, chopped  
½ cup grated Parmesan cheese

Measure all ingredients into bread pan except 1½ tablespoons olive oil, tomatoes and Parmesan cheese. Select Dough/Pasta setting. Press Start/Stop to begin. When the unit signals, the dough is finished; press Start/Stop and remove dough. Pat dough into a greased 9 x 13 inch pan. Cover; let rise for 30 minutes. With the handle of a wooden spoon make indentations in dough, about 1 inch apart. Brush dough with 1½ tablespoons olive oil, sprinkle with tomatoes and Parmesan cheese. Preheat oven to 400°F/204°C. Bake 15-20 minutes or until edges are golden brown. Let cool, cut into square pieces to serve.

## Making Quick Breads

Unlike yeast breads, quick breads do not use yeast as the rising agent. Therefore, the knead and rise cycles have been omitted. Instead, quick breads use baking powder or baking soda along with steam to act as a leavening agent.

When bread is finished, let it cool in the bread pan for 10 minutes. Remove bread and cool on a wire rack.

---

## Cranberry Nut Quick Bread

---

All ingredients at room temperature (70-80°F/21-27°C)

- 2 ounces orange juice
- 1 egg slightly beaten
- 2 tablespoons butter or margarine
- 1 cup coarsely chopped cranberries
- ½ cup chopped walnuts
- 1 tablespoon grated orange zest
- 2 cups all-purpose flour
- 1 cup sugar
- 1½ teaspoons baking powder
- 1 teaspoon salt
- ½ teaspoon baking soda

Measure orange juice, egg, butter, cranberries, nuts and orange zest into the bread pan; set aside. In medium bowl, combine remaining ingredients and mix thoroughly; add to bread pan. Select Basic setting. Press Start/Stop to begin. Allow ingredients to mix 3-5 minutes until blended. Press Start/Stop. With rubber spatula, scrape sides and corners of bread pan. Restart Basic setting, allow to mix 2 more minutes. Press Start/Stop. Select Bake and Dark crust control. Press Start/Stop. When the unit signal, the bread is finished; press Start/Stop. Let bread cool 10 minutes before removing from bread pan. Cool completely before slicing.

---

## Banana Nut Quick Bread

---

All ingredients at room temperature (70-80°F/21-27°C)

- 2 eggs, slightly beaten
- 2 medium bananas, mashed
- ⅓ cup butter or margarine
- 2 tablespoons milk
- ½ cup chopped nuts
- 2 cups all-purpose flour
- ⅔ cup sugar
- 1¼ teaspoons baking powder
- 1 teaspoon salt
- ½ teaspoon baking soda

Measure eggs, bananas, butter, milk and nuts into bread pan. In medium bowl, combine remaining ingredients; mix well and add to bread pan. Select Basic setting. Press Start/Stop to begin. Allow to mix 3-5 minutes until blended. Press Start/Stop. With rubber spatula, scrape sides and corners of bread pan. Restart Basic setting, allow to mix 2 more minutes, press Start/Stop. Select Bake and Dark crust control. Press Start/Stop. When the unit signals press Start/Stop. Let bread cool 10 minutes before removing from bread pan. Cool completely before slicing.

# Making Pasta

Making pasta is easy in the Regal Breadmaker. Just measure the ingredients into the bread pan in the order listed, select Dough/Pasta setting and press Start/Stop. When dough is ready, shape as desired either by hand or with a pasta machine. Cook pasta in boiling water (add salt if desired) until it reaches desired tenderness.

Experimentation is encouraged. Try adding a teaspoon of dried or fresh herbs to either recipe. If using your own recipe, do not exceed a total of 3 cups of flour.

---

## Basic Pasta

All ingredients at room temperature (70-80°F/21-27°C)

- 2 cups all-purpose flour
- 1 cup semolina flour
- 1 teaspoon salt
- 1 tablespoon olive oil
- 6 ounces water

Select Dough/Pasta setting. Press Start/Stop to begin. Allow to mix 2-3 minutes. Scrape sides with spatula if necessary. Press Start/Stop. Remove dough and roll out on a lightly floured surface. Roll to  $\frac{1}{8}$  inch thickness. Dust with flour if dough is sticky. Cut into  $\frac{1}{8}$  inch strips for narrow noodles or  $\frac{1}{4}$  inch for medium noodles. Cook noodles in a large pot of boiling water for 15-20 minutes or until tender; drain in a colander.

---

## Egg Pasta

All ingredients at room temperature (70-80°F/21-27°C)

- 2 cups all-purpose flour
- 1 cup semolina flour
- 1 teaspoon salt
- 1 teaspoon olive oil
- 4 large eggs
- 2 tablespoons water

Select Dough/Pasta setting. Press Start/Stop. Allow to mix 2-3 minutes. Scrape sides with spatula if necessary. Press Start/Stop. Remove dough and roll out to  $\frac{1}{8}$  inch thickness. Dust with flour if dough is sticky. Cut into  $\frac{1}{8}$  inch strips for narrow noodles or  $\frac{1}{4}$  inch for medium noodles. Cook noodles in a large pot of boiling water for 15-20 minutes or until tender; drain in a colander.

## Making Jam

Homemade jam is quick and easy to make in the Regal Breadmaker, even if you've never made it before.

1. Measure sliced, ripe fruit into the bread pan (do not exceed 2 cups sliced fruit). Peel fruits with tough skins such as apples, pears or peaches.
2. Add  $\frac{1}{2}$  to 1 cup sugar per cup of fruit depending on your preference and one package fruit pectin (powder or liquid).
3. Select Basic setting, press Start/Stop. Run just long enough to mix ingredients (about 5 minutes). Press Start/Stop. Then select Bake and press Start/Stop.
4. Set a timer for 25 minutes. When timer sounds, open cover and continue to cook for an additional 25 minutes. (Important: the last 25 minutes must be cooked uncovered to keep jam from boiling over the bread pan.) When unit signals, press Start/Stop. Spoon jam into containers and chill for one hour to complete the jelling process.
5. Store jam in a tightly covered container in the refrigerator for up to one month or in freezer for up to three months.

---

### Strawberry Jam

Not for Timer

---

- 1 pint fresh strawberries, hulled and sliced (about  $1\frac{1}{2}$  cups)
- $\frac{3}{4}$ -1 $\frac{1}{2}$  cups sugar
- 2 tablespoons lemon juice
- 1 package ( $1\frac{3}{4}$  ounces) powdered fruit pectin

Combine ingredients into bread pan. Select Basic setting. Press Start/Stop. Allow to mix 3-5 minutes. Press Start/Stop. (Scrape sides with spatula if necessary). Select Bake setting. Press Start/Stop. Set a timer for 25 minutes. When timer sounds, open cover and continue to cook for an additional 25 minutes. (Important: the last 25 minutes must be cooked uncovered to keep jam from boiling over the bread pan.) When the unit signals, press Start/Stop. Using hot pads, remove bread pan. Spoon jam into containers; cover and refrigerate for one hour to set.  
Makes about 2 cups.

---

## Orange Marmalade

Not for Timer

---

- 3 oranges, large
- 1 lemon
- 2½ cups sugar
- 1 package (1¾ ounces) powdered fruit pectin

Peel oranges and lemon. Slice fruit into ½ inch pieces. Combine all ingredients into bread pan. Select Basic setting. Press Start/Stop. Allow to mix 3-5 minutes. Press Start/Stop. (Scrape sides with spatula if necessary). Select Bake setting. Press Start/Stop. Set a timer for 25 minutes. When timer sounds, open cover and continue to cook for an additional 25 minutes. (Important: the last 25 minutes must be cooked uncovered to keep jam from boiling over the bread pan.) When the unit signals, press Start/Stop. Using hot pads, remove bread pan. Spoon jam into containers and refrigerate for 1 hour to set. Makes about 3 cups.

---

## Frozen Berry Jam

Not for Timer

---

- 1 package (10-12 ounces) frozen berries, thawed  
(strawberries & raspberries are ideal)
- 1 tablespoon lemon juice
- 1¾ cups sugar
- 1 pouch (3 ounces) liquid fruit pectin

Combine all ingredients. Select Basic setting. Press Start/Stop. Allow to mix 3-5 minutes. Press Start/Stop. (Scrape sides with spatula if necessary). Select Bake setting. Press Start/Stop. Set a timer for 25 minutes. When timer sounds, open cover and continue to cook for an additional 25 minutes. (Important: the last 25 minutes must be cooked uncovered to keep jam from boiling over the bread pan.) When the unit signals, press Start/Stop. Using hot pads, remove bread pan. Spoon jam into containers; cover and refrigerate for 1 hour to set.

# Recipe Index

<b>Bread Recipes</b>	
Classic White . . . . .	24
Cottage Cheese Chive . . . . .	27
Country White. . . . .	25
Cracked Wheat . . . . .	30
French. . . . .	28
Honey French. . . . .	29
Honey Wheat . . . . .	30
Italian . . . . .	29
Oat Bran . . . . .	26
Oatmeal. . . . .	26
Old Fashioned. . . . .	25
Raisin . . . . .	27
Rye. . . . .	28
Whole Wheat II . . . . .	31
Whole Wheat - 100% . . . . .	31
<b>Gluten Free Bread Recipes</b>	
Cheddar Cheese Bread . . . . .	33
Cinnamon Raisin. . . . .	34
Mock Limpa Bread . . . . .	34
Sourdough Rye Bread. . . . .	36
Sourdough Starter . . . . .	35
Sourdough White Bread . . . . .	36
White Bread . . . . .	33
<b>Dough Recipes</b>	
Addie's Coffee Cake. . . . .	45
Bran Buns . . . . .	44
Bread Pretzels. . . . .	44
Cinnamon Rolls. . . . .	48
Focaccia . . . . .	49
Pizza Crust . . . . .	47
Pizza Toppings . . . . .	48
Reuben Bake . . . . .	46
Whole Wheat Pizza Crust . . . . .	47
<b>Quick Bread Recipes</b>	
Banana Nut . . . . .	50
Cranberry Nut. . . . .	50
<b>Pasta Recipes</b>	
Basic Pasta . . . . .	51
Egg Pasta . . . . .	51
<b>Jam Recipes</b>	
Frozen Berry Jam . . . . .	53
Orange Marmalade . . . . .	53
Strawberry Jam . . . . .	52